

COMPONENT SIDE

COMPONENT SIDE (Gray)  
 SOLDER SIDE (Pink)  
 OVERLAY -----

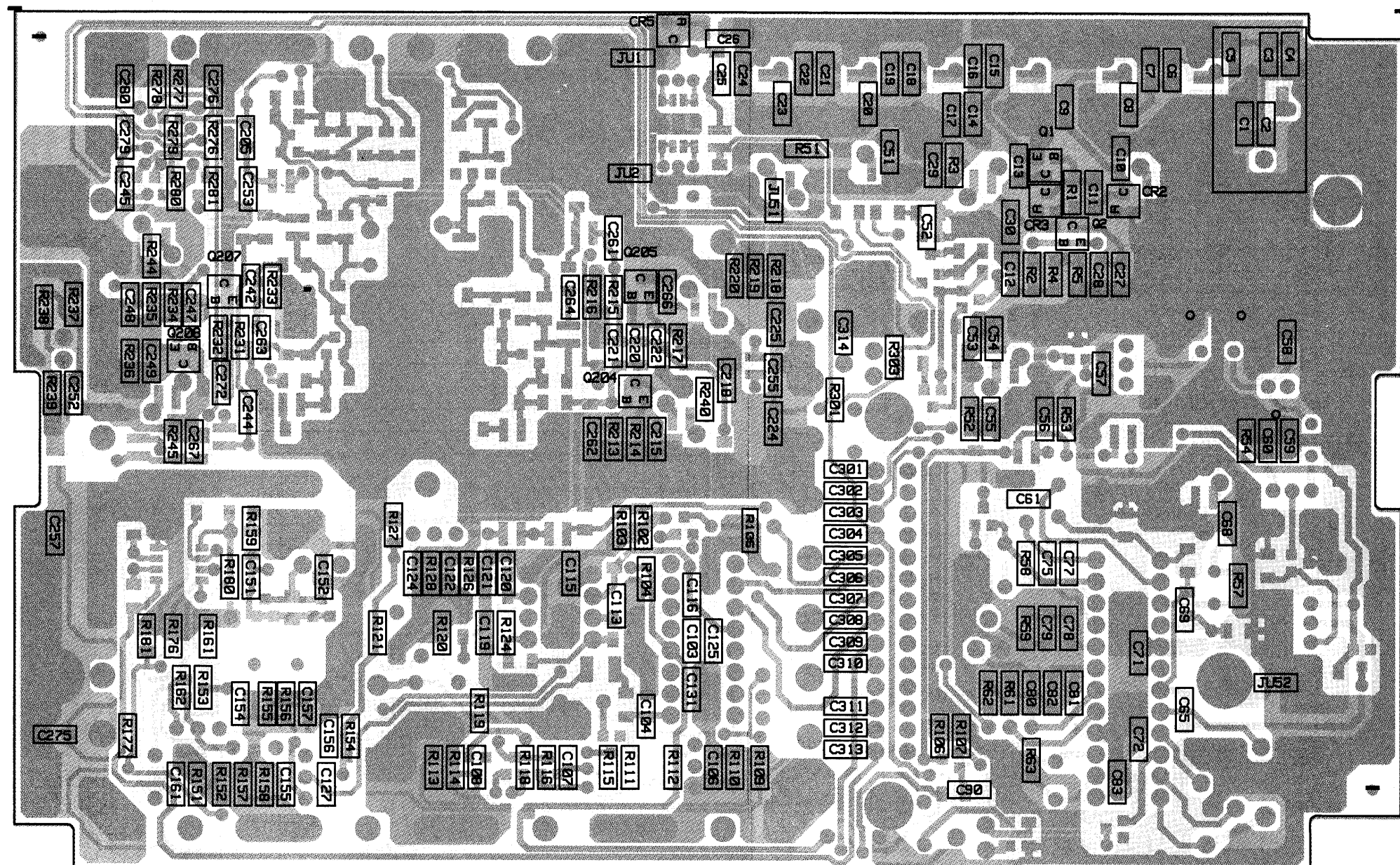

SOLDER SIDE

COMPONENT SIDE (Gray)  
 SOLDER SIDE (Pink)  
 OVERLAY -----



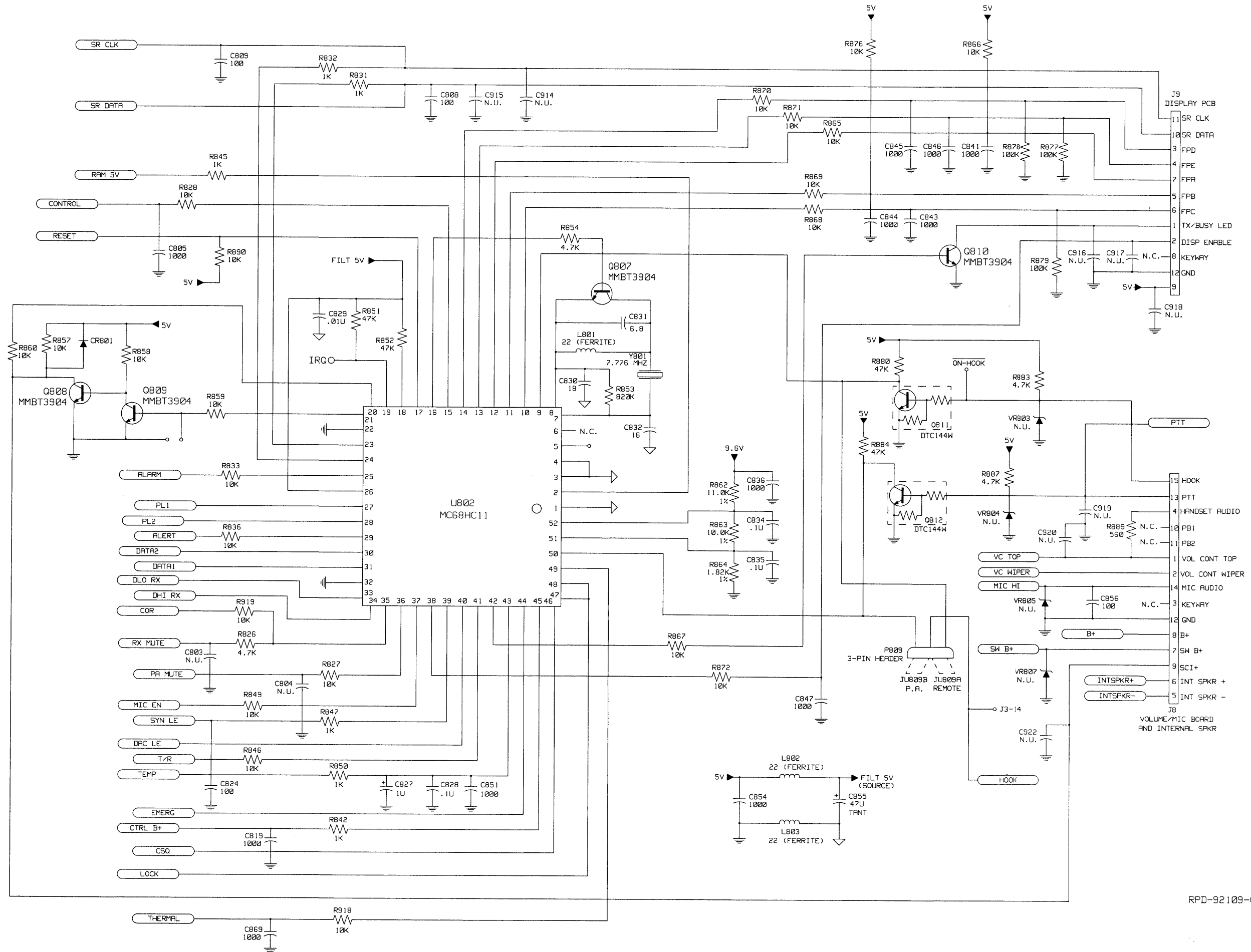

Schematic Diagram for HLN8074A  
Masked Logic Board (2-Layer)  
(Sheet 2 of 2)

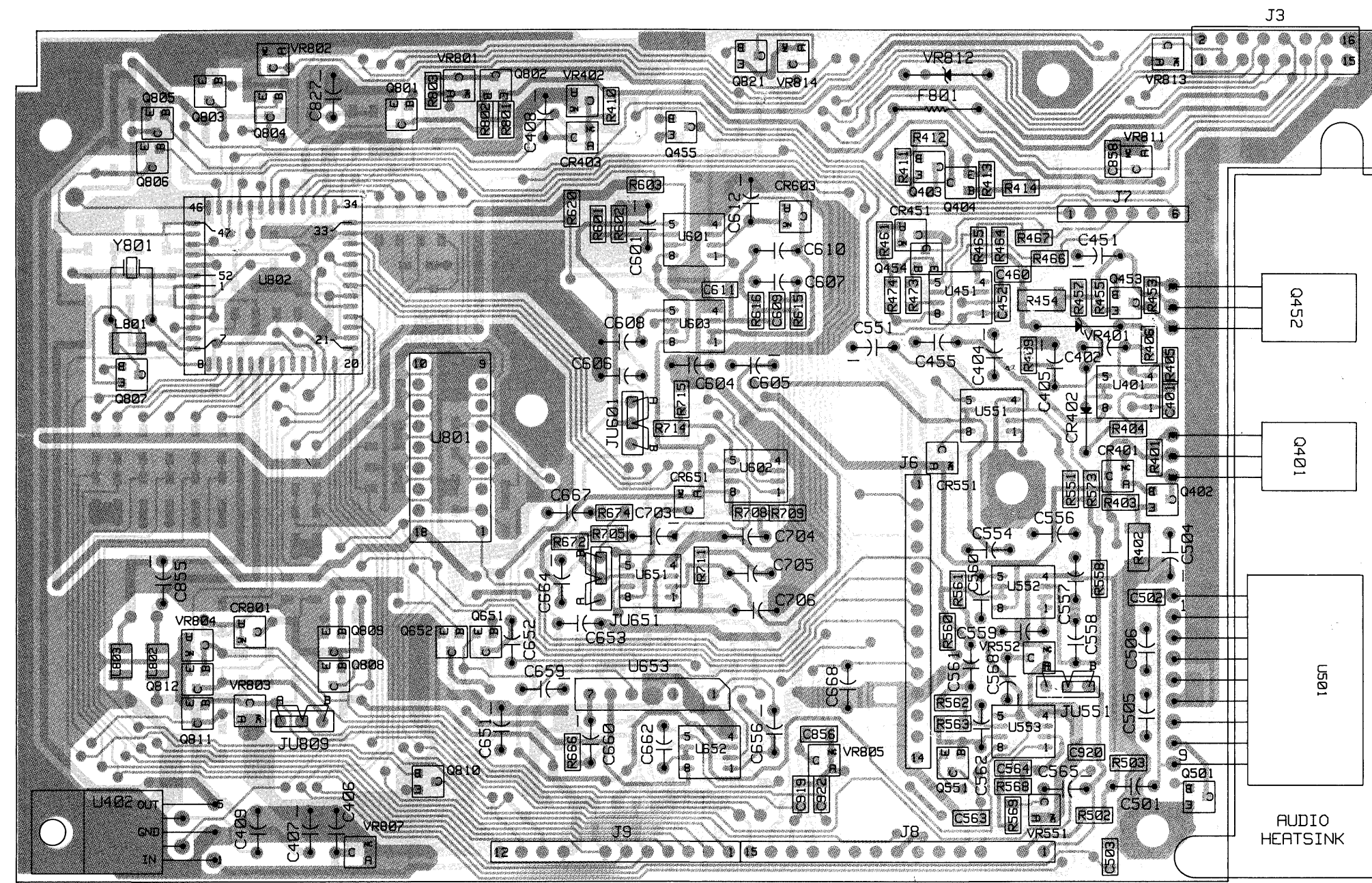

COMPONENT SIDE (Gray)  
 SOLDER SIDE (Pink)  
 OVERLAY -----

COMPONENT SIDE

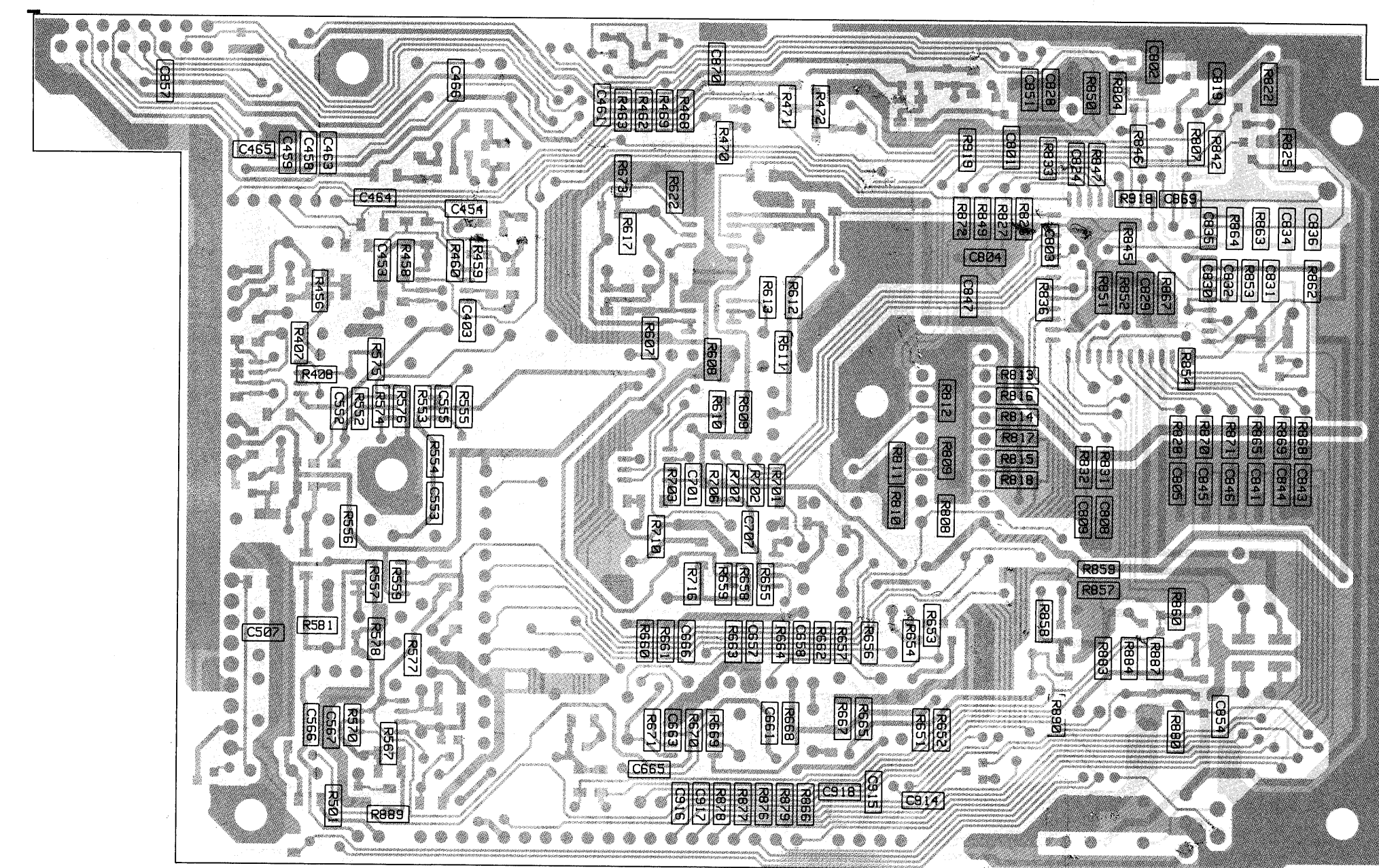

COMPONENT SIDE (Gray)  
 SOLDER SIDE (Pink)  
 OVERLAY -----

SOLDER SIDE



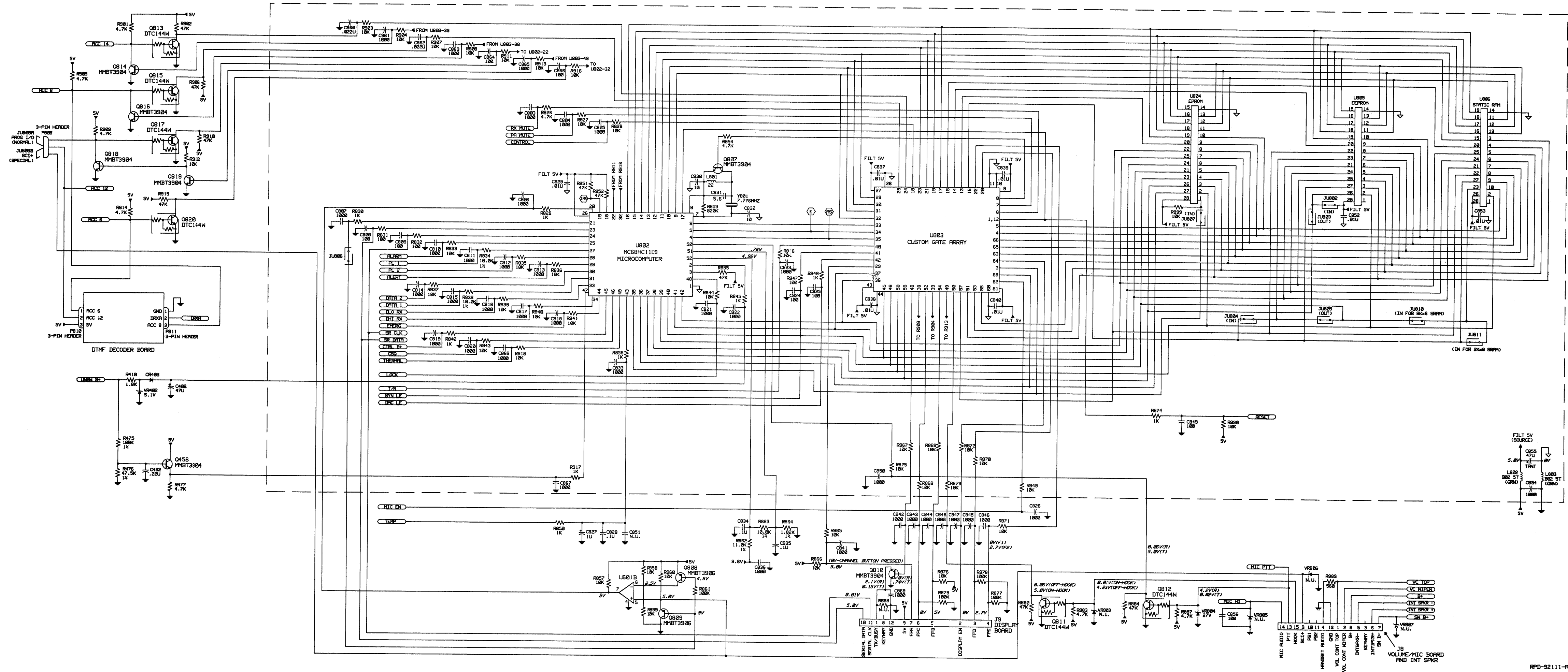

Schematic Diagram for HLN8070A  
Expanded Logic Board (4-Layer)  
(Sheet 2 of 2)

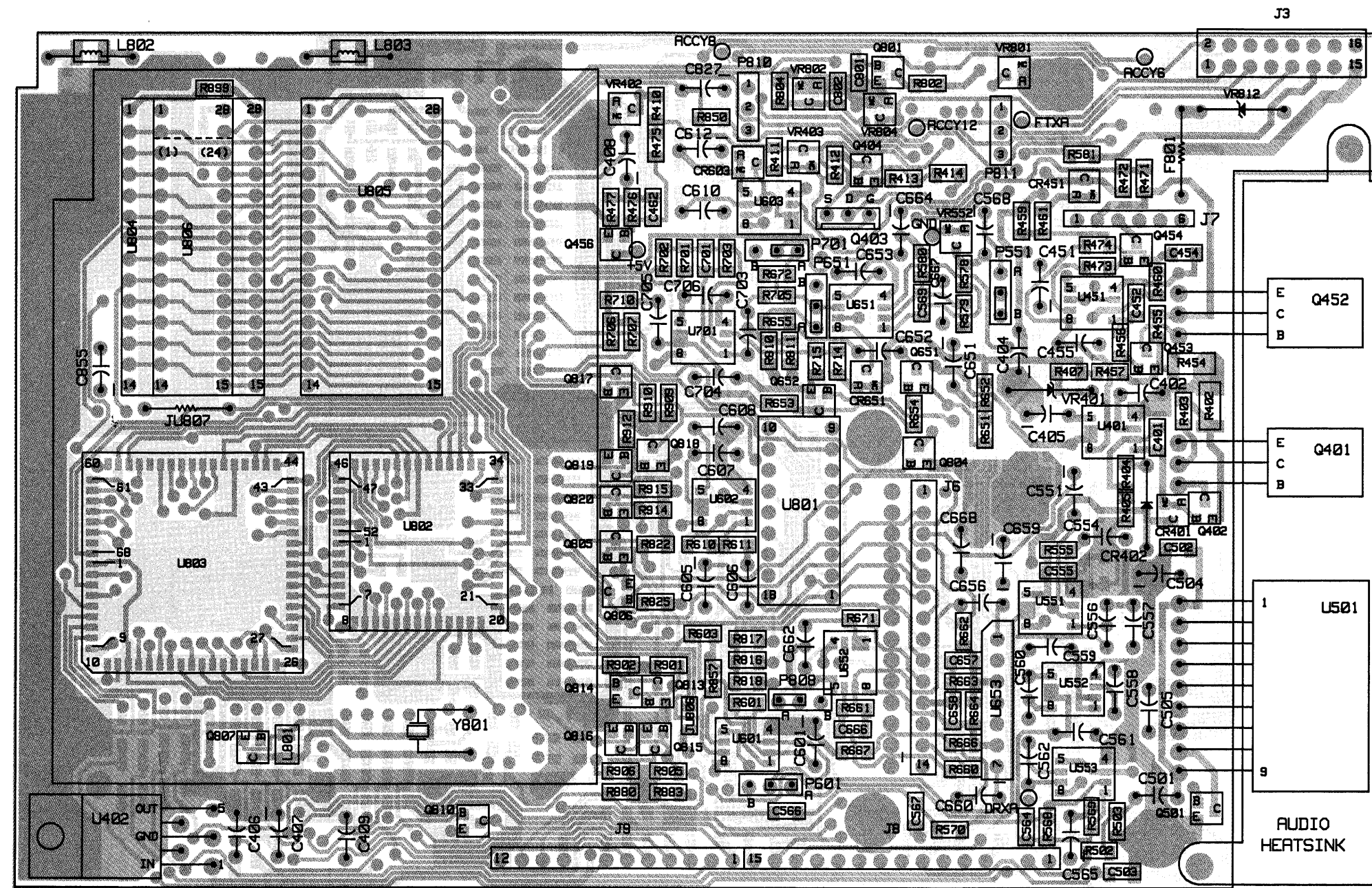

COMPONENT SIDE

COMPONENT SIDE (Gray)  
 SOLDER SIDE (Pink)  
 OVERLAY -----

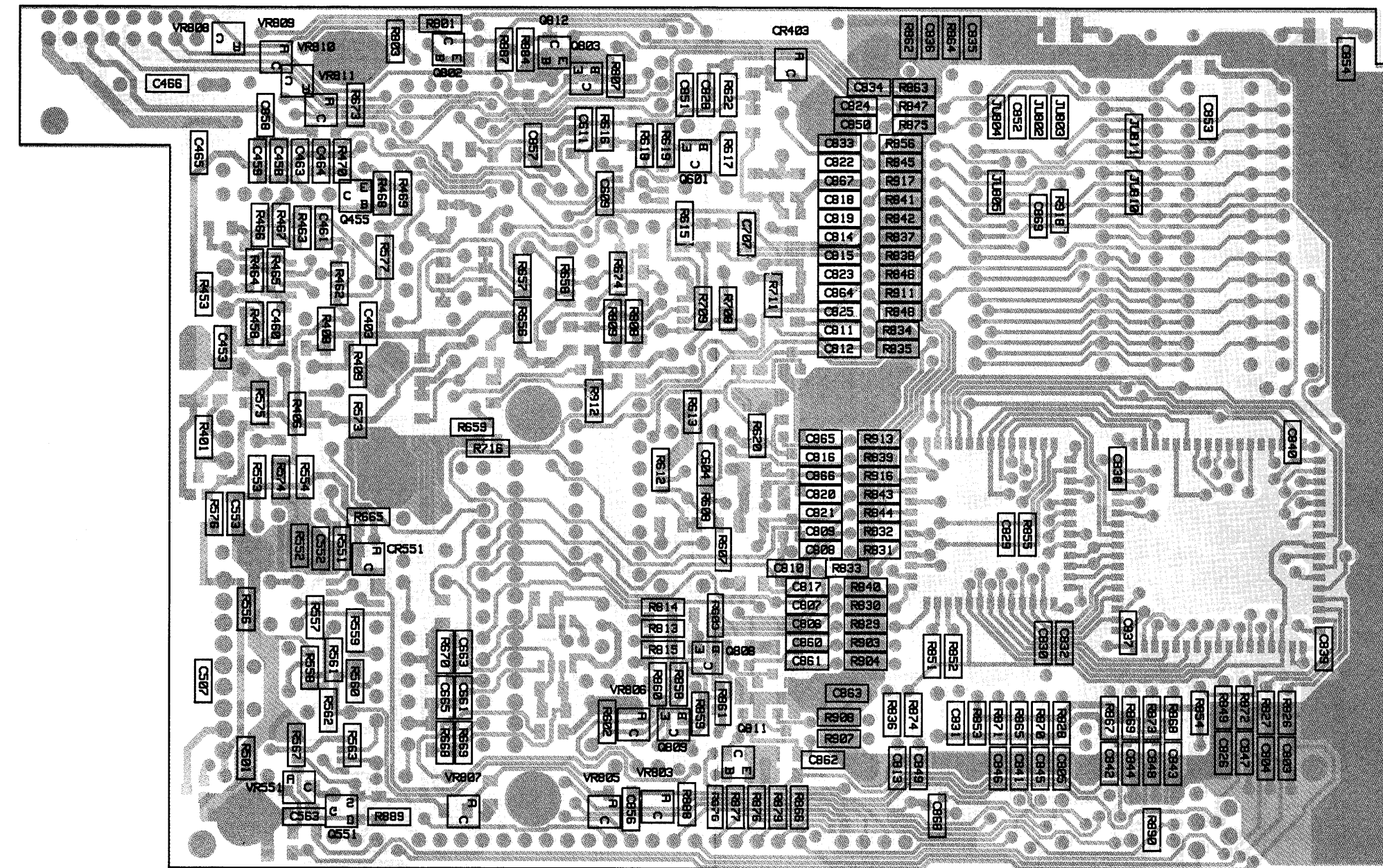

SOLDER SIDE

COMPONENT SIDE (Gray)  
 SOLDER SIDE (Pink)  
 OVERLAY -----

NOTE: 2 INNER LAYERS NOT SHOWN